

Flat Belt Conveyors

With Meandering Prevention Crosspiece, Head Drive, 3-Groove Frame (Pulley Dia. 50mm)

Dedicated web site <http://fa.misumi.jp/cvs/>
 Conveyor selecting, component purchases, and easy search for maintenance parts are available.

■ **Features:** The conveyor maintains good running straightness by the use of meandering prevention crosspiece to suppress lateral force induced meandering. Superior to CVSD in maintainability and space saving.

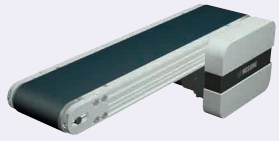

CVGD 6W Motor Type

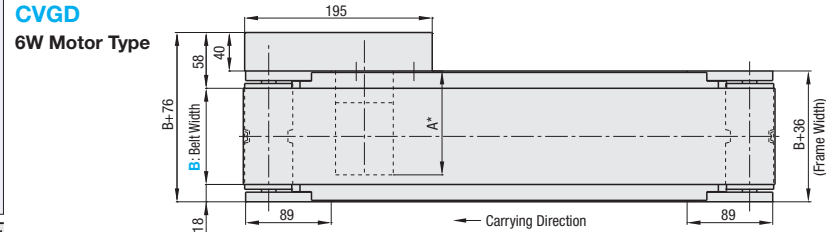

	Frame	Motor Cover	Pulley Holder
M Material	Aluminum	Aluminum	Aluminum
S Surface Treatment	Clear Anodize	Paint	Paint

Frame Cross Section and Enlarged View (Symmetrical)

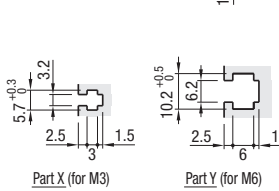
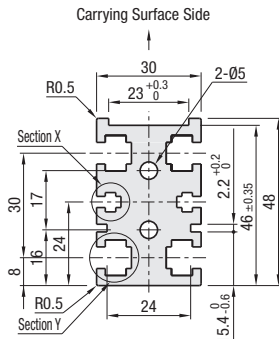

Compatible with JIS standard hex nuts.

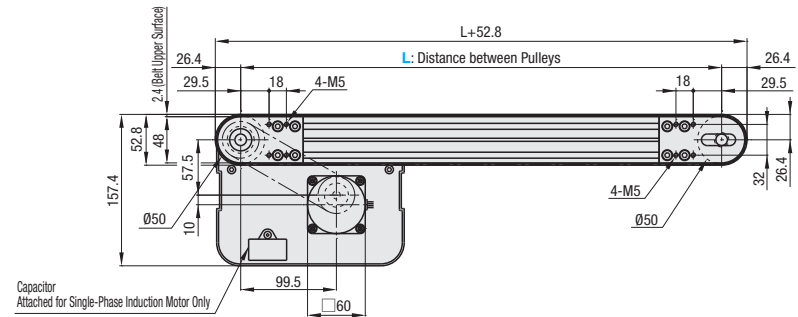

25W Motor Type

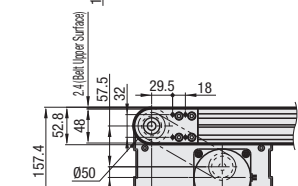
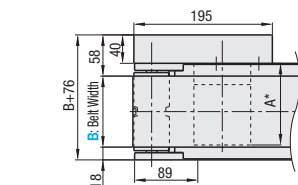

40W Motor Type

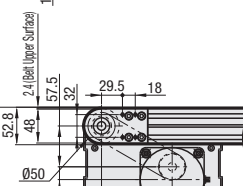
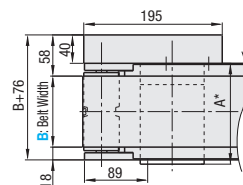

* When L≥340, each slot has four (4) nuts inserted. When counterbores for inserting nuts are required, please specify in alterations.
 * The dimensions in the diagram is for Belt Specifications H (0.8mm THK). Take note that belt thickness varies by Belt Specifications. For Belt Specifications, see P.1279-.

* A Dimension Details

Output (W)	Motor Specification	Manufacturer	Reduction Ratio	A
6W	Induction Motor	Panasonic	5-25	101.0
			30-180	108.0
		Oriental	5-25	105.0
			30-180	115.0
			5-75	114.7
	Variable Speed Motor	Taiwanese	90-180	120.7
			5-25	115.0
		Oriental	30-180	125.0
			5-75	126.9
			90-180	132.9
25W	Induction Motor	Panasonic	5-180	115.0
			5-18	117.0
		Oriental	25-180	127.5
			5-75	129.0
			90-180	136.0
	Variable Speed Motor	Taiwanese	5-18	127.0
			25-180	137.5
		Oriental	5-75	139.5
			90-180	146.5

Output (W)	Motor Specification	Manufacturer	Reduction Ratio	A
40W	Induction Motor	Panasonic	5-180	142.0
			5-18	147.0
		Oriental	25-180	165.0
			5-75	161.6
			90-180	170.6
	Variable Speed Motor	Oriental	5-18	157.0
			25-180	175.0
		Taiwanese	5-75	172.1
			90-180	181.7

■ Conveying Capacity

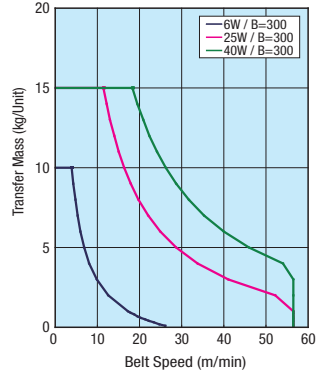

*Reference Value may different by selected Belt.

■ Gearhead Reduction Ratio

*May decrease depending on load condition.

Gearhead Reduction Ratio	Belt Speed (m/min)	
	50Hz	60Hz
5	47.1	56.5
7.5	31.4	37.7
9	26.2	31.4
12.5	18.8	22.6
15	15.7	18.8
18	13.1	15.7
25	9.4	11.3
30	7.9	9.4
36	6.5	7.9
50	4.7	5.7
60	3.9	4.7
75	3.1	3.8
90	2.6	3.1
100	2.4	2.8
120	2.0	2.4
150	1.6	1.9
180	1.3	1.6

Part Number	B 1mm Increment	L 5mm Increment	Motor				Belt Specification	Motor Manufacturer Selection				
			Output (W)	Voltage (V)	Specification	Gearhead Reduction Ratio						
CVGD	50-300	240-2000	6	TA115 (Single-phase)	IM (Induction Motor) SCM (Variable Speed Motor)	5	7.5	9	12.5	15	H (General Purpose, Green) W (General Purpose, White) G (For Sliding, Green) S (For Sliding, White) D (For Electronic Parts Transfer) O (Oil Resistant) N (Non-adhesive) J (No Belt)	A (Panasonic Motor) B (Oriental Motor) C (Taiwanese Motor) *SCM (Variable Speed Motor) is not selectable for A. R (No Motor, Gearhead)
			25			18	25	30	36	50		
			40			60	75	90	100	120		
			25	SA220 (3-Phase) SA230 (3-Phase)	IM (Induction Motor)	*5-9 not applicable for 6W Motor						
			6			NV (No Motor)	NM (No Motor)	NH (No Gearhead)				
			25									
40												

- Connect the motor so that the belt rotates in the direction of conveyance. For connection diagram, and details of motor, see P.1267 onward.
- When "No motor, gearhead" is selected, the motor mounting hole pitch will vary depending on the motor's power rating. Please see Technical Information in our Conveyor Selection web site for the dimension details.
- When "No motor, gearhead" is selected, this unit will be delivered unassembled. The customer is to assemble the unit according to the included assembly instructions. See our Conveyor Selection site for assembly procedures and packaging details.
- Note that warpage might occur in belts with meandering prevention crosspiece depending on the number of plies (thickness).

Belt Specification	Standard Belt (Body Price Only)	Optional Belt 1	Optional Belt 2	No Belt
General Purpose	H (Green), W (White)	-	-	J (No Belt)
For Sliding	G (Green), S (White), SN (White)	-	-	
For Inclined Transfer	-	-	-	
Grip Type	-	-	GG (Green), GW (White)	
Oil Resistant	O (Green)	OW (White)	-	
Non-adhesive	N (White)	NB (Sky Blue), NBG (Lime Green) HH (Green), HW (White)	-	
For Food Transfer	-	KW (White), KSB (Sky Blue), PHB (Sky Blue)	-	
For Electronic Parts Transfer	D (Black)	-	-	

- For flat belt details, see P.1279 onward.
- In case of selecting Optional Belts, please select motor manufacturer A or B (Motor C is applicable for Standard Belt only).

Part Number	B	Body Price 1 ~ 2 pc(s).																		
		L240-300	L305-400	L405-500	L505-600	L605-700	L705-800	L805-900	L905-1000	L1005-1100	L1105-1200	L1205-1300	L1305-1400	L1405-1500	L1505-1600	L1605-1700	L1705-1800	L1805-1900	L1905-2000	
CVGD	50-100																			
	110-150																			
	160-200																			
	210-250																			
	260-300																			

For orders larger than indicated quantity, please check with WOS.

Motor Spec. Price	Motor Output	Specification	A (Panasonic Motor)	B (Oriental Motor)	C (Taiwanese Motor)	R (No Motor, Gearhead)
6W	6W	IM				
25W	25W	SCM				
40W	40W	SCM				

Belt Spec. Price	Standard Belt	Optional Belt 1	Optional Belt 2	No Belt

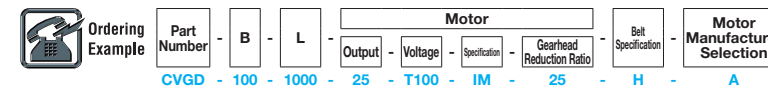

- Ex.) For No Belt: CVGD-100-1000-25-T100-SCM-25-J-B
- Ex.) For Optional Belt 2: CVGD-100-1000-25-T100-SCM-25-HY-B
- Ex.) For No Motor, Gearhead: CVGD-100-1000-25-NV-NM-NH-H-R

Body Price + Motor, Belt Spec. Price = Unit Price

- Motor Position Reversed
- Additional Counterbores
- Motor Cover with Window
- Brackets for Speed Controller Included
- Post-Assembly Insertion Nuts Included
- Motor with Terminal Box
- Stands (Legs)

For details of alterations, see P.1264 onward.