

DOWEL PINS

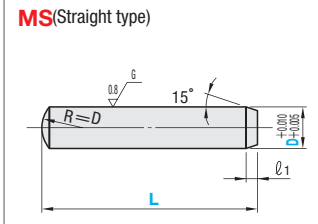

Printed in Red

The quantity discount rate is also applicable to alteration cost. All price & lead time are to be quoted.

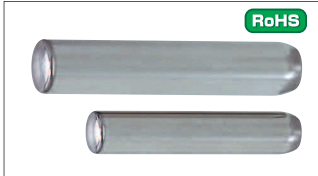

M SUJ2
H 58HRC ~

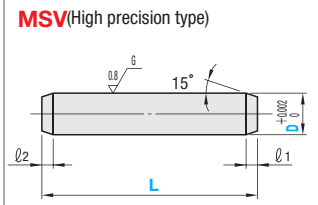

M SUJ2
H 58HRC ~

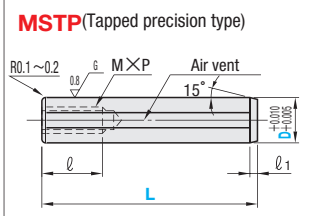

M SUJ2
H 58HRC ~

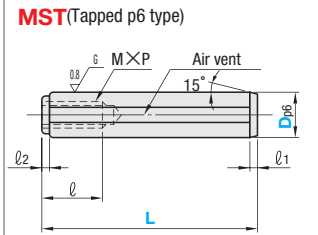

M SUJ2
H 45~50HRC

Dimension ℓ_1 and ℓ_2 are reference values. They may sometimes become greater depending on the results of grinding of outer diameter.

ℓ_1	ℓ_2	Catalog No. Type	D	L	U/Price			
					Q'ty:1~299	300~499	500~1999	2000~4000
0.4	0.6	1	6 8 10					
1.0	2	6 8 10 15						
								2.5
1.5	3	6 8 10 15 20	25 30 35 40					
								2.0
2.5	5	10 15 20 25 30	35 40 45 50					
								3.0
3.5	8	10 15 20 25 30	30 40 50					
	12	20 25 30 35 45 55 70 80	40 50 60					

Quotation

ℓ_1	ℓ_2	Catalog No. Type	D	L	U/Price			
					Q'ty:1~299	300~499	500~1999	2000~4000
1.0	0.2	2	6 8 10					
2.0	4	10 15 20 25 30						
								2.5
3.0	6	10 15 20 25 30						

Quotation

The high precision dowel pins are measured in a thermostatic chamber.

ℓ_1	ℓ_2	M X P	ℓ	D	Catalog No. Type	D	L	U/Price			
								Q'ty:1~299	300~499	500~1999	2000~4000
1.5	0.3	M3 X 0.5	*6		5	10 15 20 25 30					
2.5	8	15 20 25 35 40 45 50 60 70 80									
								3.0	10	15 20 25 30 35 45 50 60 70 80	
	12	20 30 40 50 60 70 80									
									13	40 50 60 70 80	
	16	40 50 60 70 80									

Quotation

* $\ell=6$ is a reference value when D = 5. * Only when D = 6 and L = 10, $\ell=6$.

ℓ_1	ℓ_2	M X P	ℓ	Dp6	Catalog No. Type	D	L	U/Price			
								Q'ty:1~299	300~499	500~1999	2000~4000
1.5	0.5	M3 X 0.5	*6	+0.020	5	10 15 20 25 30					
2.5	8	15 20 25 35 40 45 50 60 70 80									
								3.0	10	15 20 25 30 35 45 50 60 70 80	
	12	20 30 40 50 60 70 80									
									13	40 50 60 70 80	
	16	40 50 60 70 80									
									18	50 60 70 80	

Quotation

* $\ell=6$ is a reference value when D = 5. * Only when D = 6 and L = 10, $\ell=6$.

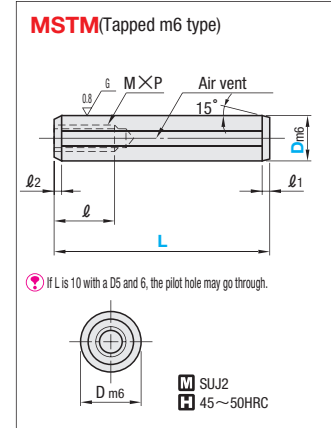

M SUJ2
H 45~50HRC

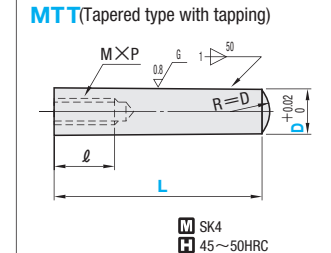

M SK4
H 45~50HRC

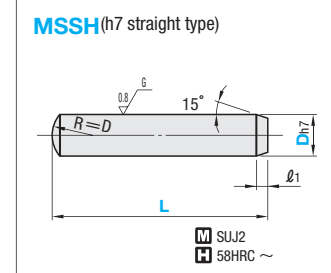

M SUJ2
H 58HRC ~

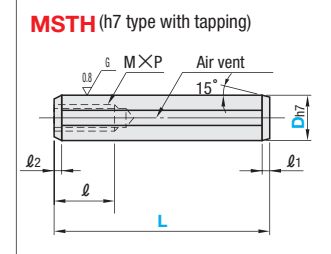

M SUJ2
H 45~50HRC

Dimension ℓ_1 and ℓ_2 are reference values. They may sometimes become greater depending on the results of grinding of outer diameter.

ℓ_1	ℓ_2	M X P	ℓ	Dm6	Catalog No. Type	D	L	U/Price			
								Q'ty:1~299	300~499	500~1999	2000~4000
1.5	0.3	M3 X 0.5	*6	+0.012	5	10 15 20 25 30					
2.5	8	15 20 25 30 35 40 45 50 60 70 80									
								3.0	10	15 20 25 30 35 45 50 60 70 80	
	12	20 30 40 50 60 70 80									
									13	40 50 60 70 80	
	16	40 50 60 70 80									
									20	50 60 70 80	

Quotation

* $\ell=6$ is a reference value when D = 5. * Only when D = 6 and L = 10, $\ell=6$.

M X P	ℓ	Catalog No. Type	D	L	U/Price			
					Q'ty:1~299	300~499	500~1999	2000~4000
M5 X 0.8	9	8	30 40					
M6 X 1.0	10	12	40 50					
								M8 X 1.25
M10 X 1.5	16	16	60 70					

Quotation

ℓ_1	Dh7	Catalog No. Type	D	L	U/Price			
					Q'ty:1~299	300~499	500~1999	2000~4000
1.0	0 -0.010	2	6 8 10 15					
1.5	0 -0.012	4	10 15 20					

Quotation

ℓ_1	ℓ_2	M X P	ℓ	Dh7	Catalog No. Type	D	L	U/Price			
								Q'ty:1~299	300~499	500~1999	2000~4000
1.5	0.3	M3 X 0.5	*6	0	5	10 15 20 25 30					
2.5	8	15 20 25 30 35 40 45 50 60 70 80									
								3.0	10	15 20 25 30 35 40 45 50 60 70 80 100 120	
	12	20 30 40 50 60 70 80 100 120									
									13	40 50 60 70 80 100 120	
	16	40 50 60 70 80 100 120 150									
									20	60 70 80 100	

Quotation

* $\ell=6$ is a reference value when D = 5. * Only when D = 6 and L = 10, $\ell=6$.

Order **Catalog No.** L
MS2 - 20
 • Printed in Red • Other Product
 Delivery **SGP Stock** 3 Days
 • For area out of Singapore, please refer to P.i.

Depth of Air Vent 0.15
 Since these products are finished by barrel finishing, this value is for reference only. Same depth is applied to all dimension D.
 Subject item :MSTP
 MST
 MSTM
 MSTH

Stocks Availability Subjected to Prior Sales.